

Bracket R

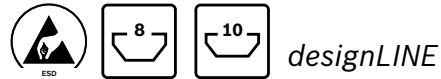

- ▶ For connecting profiles at any angle
- ▶ No protruding edges due to rounding of bracket
- ▶ Brackets with centering lugs for rapid, precise assembly with protection against turning
- ▶ Centering lugs can be easily broken off for assembly on plates or at right angles to the slot
- ▶ *designLINE* version with special silver paint (RAL 9006) for an attractive, high-quality design
- ▶ Profile finishing: not required

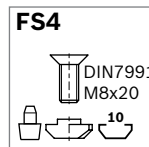
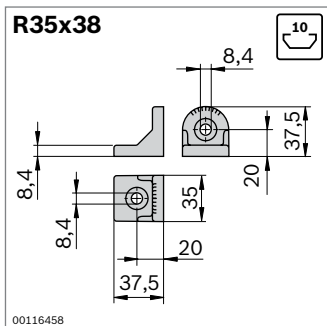
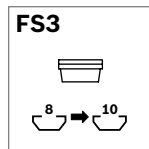
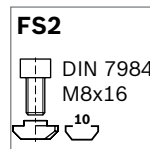
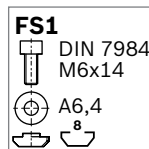
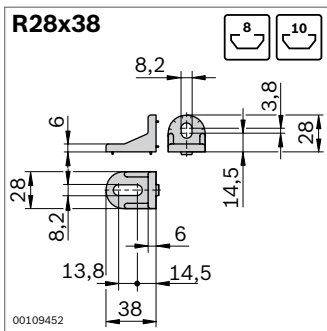

R28x38	Slot	ESD	No.	FS
Set (standard)	8 / 10	⚠	1	3 842 515 547 FS1, FS2, 2xFS3
	10 / 10	⚠	1	3 842 521 580 2xFS2, 4xFS3
<i>designLINE</i> set	8 / 10	⚠	1	3 842 538 703 FS1, FS2, 2xFS3
	10 / 10	⚠	1	3 842 538 704 2xFS2, 4xFS3
Bracket (standard)	8, 10	⚠	100	3 842 515 473

Material: Bracket: diecast zinc
*designLINE*bracket: painted (RAL 9006)
Adapter: PA; black
Fastening material: steel; galvanized

Scope of delivery: set incl. fastening material (FS)

R35x38	Slot	ESD	No.	FS
Set (standard)	10 / 10	⚠	1	3 842 532 274 2xFS4
<i>designLINE</i> set	10 / 10	⚠	1	3 842 538 705 2xFS4
Bracket (standard)	10	⚠	100	3 842 529 020

Material: Bracket: Die-cast aluminum
*designLINE*bracket: painted (RAL 9006)
Centering bolts: PA6, black
Fastening material: steel; galvanized

Scope of delivery: set incl. fastening material (FS)

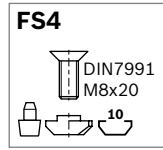
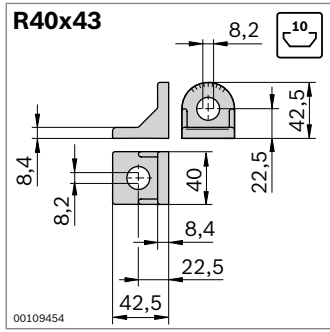

R40x43	Slot	ESD		No.	FS
Set (standard)	10 / 10		1	3 842 518 424	2xFS4
<i>designLINE</i> set	10 / 10		1	3 842 538 706	2xFS4
Bracket (standard)	10		100	3 842 504 760	

Material: Bracket: diecast zinc
designLINE bracket: painted (RAL 9006)
 Centering bolts: PA6, black
 Fastening material: steel; galvanized

Scope of delivery: set incl. fastening material (FS)